

Work happily



V1.2

naggura'swop

naggura.com

# Swop 5 Physio

  Physiotherapy



## Dimensions

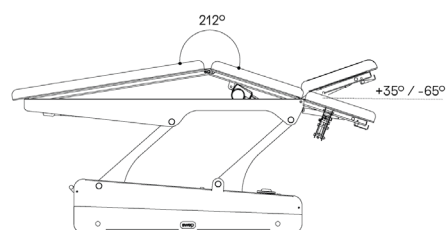
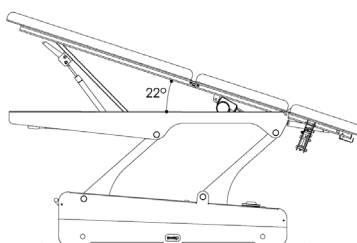
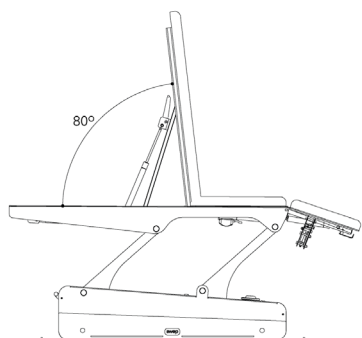
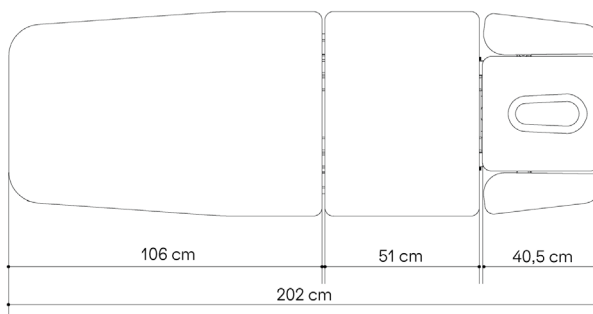
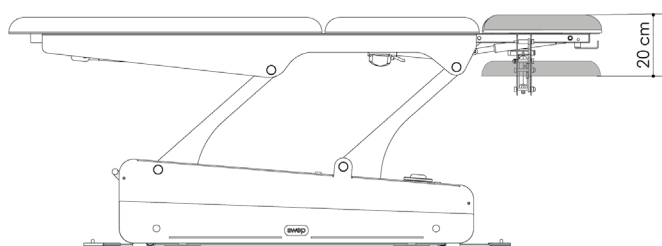
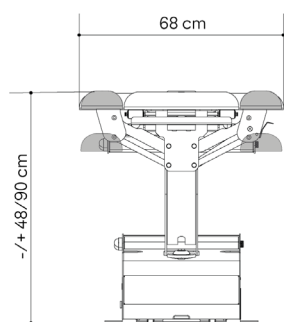



### General Specifications

#### MOTORS

1 engine height (6000N)  
1 engine middle section (6000N)

#### DIMENSIONS (LENGTH X WIDTH)

202 x 68 cm

#### HEIGHT (MIN. AND MAX.)

48/90 cm

#### WEIGHT

102 kg

#### LIFTING CAPACITY

200 kg

#### POWER SUPPLY

230 V - 50/60 Hz

#### FRAME COLOUR

Space ball is RAL 7015  
Base Frame is RAL 7047

#### INSULATION CLASS

Reinforced insulation II

#### PRODUCT CLASSIFICATION

Class I Equipment

#### APPLIED PARTS

Type B

#### MOISTURE RESISTENCE

IPx0

#### FEEDER CABLE

2,5m, white

### Operation

TwinLift® arm supports: stepless and simultaneously adjustable with gas spring. No collision with the therapist.

Head section with 2 gas springs.

Space ball peripheral switch, easy access from all sides of the table.

4 wheels turning 360°. Fully integrated system underneath the base frame. 1 Central lever.

Electrically adjustable middle section. Switches on both sides.

Foot section with 1 gas spring

### Upholstery

Thickness: 5cm

Density: 40kg/m<sup>3</sup>

Breathing hole and plug.

Seamless upholstery with round edges.

Naggura Skin upholstery: 100% vinyl compound.

Protection against germs and UV rays.

Superior abrasion resistance: >250K cycles.

Flame retardancy: NF P 92-503/M1

Colour: Graphite

### Warranty and conformity

#### WARRANTY

2 years on table and upholstery

#### CONFORMITY

EN ISO 14971: 2019, EN ISO 20417:2021,

EN ISO 15223-1: 2016, ISO 10993-1: 2018,

EN ISO 10993-5: 2009, EN ISO 10993-10: 2013,

EN ISO 13485:2016,

EN 60601-2-52:2010+ AC:2011+A1:2015,

EN 60601-1-2:2015+ A1:2020,

EN 60601-1:2006+ A1:2013+AC:2014+A12:2014 +A2:2020

### Collections



#### Nordic

METAL



Yellow



Blue



Pink

#### Foll

METAL



Ash



Clay

#### Iron

METAL



Inox



Black

#### Om

WOOD



Oak



Wenge

#### Techno

PMMA



Fluor



Fuxia



Ice

### Accessories

#### Paper roll holder



#### Bed Covers



### Safety

Safety switch with key (power off).

Motor with safety clutch.

# Swop 5 Physio

  Physiotherapy



## Dimensiones y Funciones

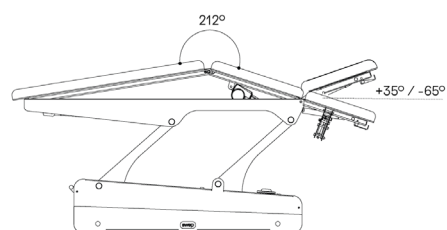
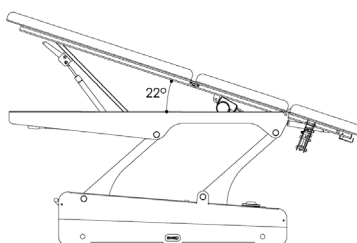
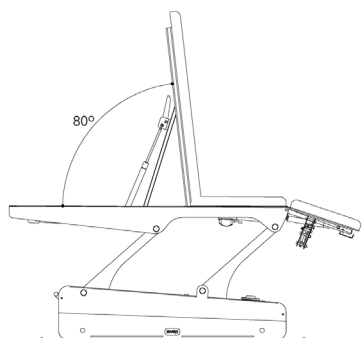
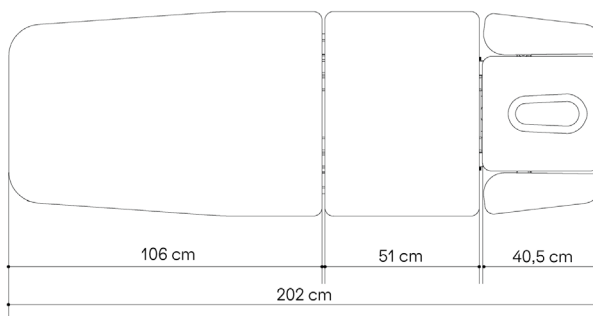
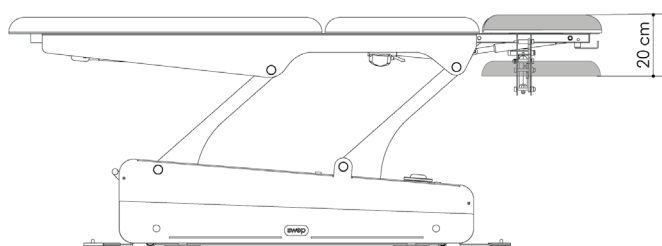
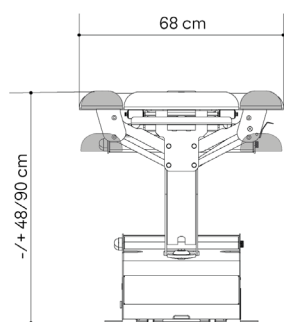

## Características técnicas

### MOTORES

1 motor altura (6000 N)  
1 motor sección central (6000 N)

### DIMENSIONES (LARGOxANCHO)

202 x 68 cm

### ALTURA (MIN. Y MAX.)

48/90 cm

### PESO

102 kg

### CAPACIDAD DE CARGA

200 kg

### FUENTE DE ALIMENTACIÓN

230 V - 50/60 Hz

### COLOR DE LA ESTRUCTURA

Space ball: RAL 7015  
Base Frame: RAL 7047

### CLASE DE AISLAMIENTO

Aislamiento reforzado II

### CLASIFICACIÓN PRODUCTO

Equipamiento Clase I

### TIPO DE COMPONENTE

Tipo B

### RESISTENCIA HUMEDAD

IPx0

### CABLE DE ALIMENTACIÓN

2,5m, blanco

## Funcionalidades

Reposabrazos TwinLift®: ajuste simultáneo y continuo mediante pistón de gas. Evita posibles colisiones con el terapeuta.

Cabezal con dos pistones.

Sistema perimetral Space ball, accesible desde cada lado de la camilla.

4 ruedas con giro 360°. Sistema completamente integrado bajo la estructura de la base accionado con una palanca.

Sección central ajustable eléctricamente. Botonera en ambos laterales. Perna con 1 pistón de gas.

## Tapizados

Espesor: 5cm

Densidad: 40kg/m<sup>3</sup>

Agujero y cojín facial.

Borde redondeado sin costuras.

Tapizado con Naggura Skin: 100% Mezcla de vinilo.

Protección contra gérmenes y rayos UV.

Resistencia superior a la abrasión: >250K ciclos.

Protección ignífuga: NF P 92-503/M1

Color: Grafito

## Garantía y conformidad

### GARANTÍA

2 años (camilla y tapizado)

### CONFORMIDAD

EN ISO 14971: 2019, EN ISO 20417:2021,

EN ISO 15223-1: 2016, ISO 10993-1: 2018,

EN ISO 10993-5: 2009, EN ISO 10993-10: 2013,

EN ISO 13485:2016,

EN 60601-2-52:2010+ AC:2011+A1:2015,

EN 60601-1-2:2015+ A1:2020,

EN 60601-1:2006+ A1:2013+AC:2014+A12:2014 +A2:2020

## Colecciones

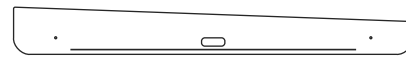

### Nordic

METAL



Yellow



Blue



Pink

### Foll

METAL



Ash



Clay

### Iron

METAL



Inox



Black

### Om

MADERA



Oak



Wenge

### Techno

PMMA



Fluor



Fuxia



Ice

## Accesorios

Portarrollos de papel



Funda de protección



## Seguridad

Botón de seguridad con llave (apagar).

Motor con embrague de seguridad.

# Swop 5 Physio



Physiotherapy



## Dimensions et Fonctions

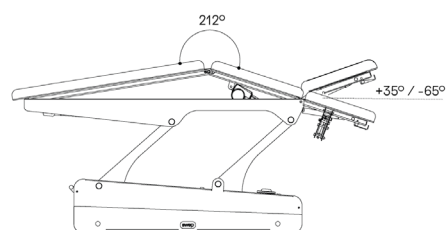
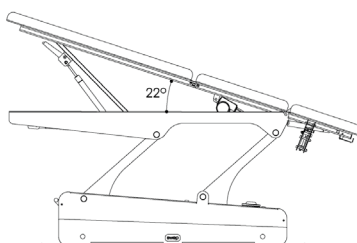
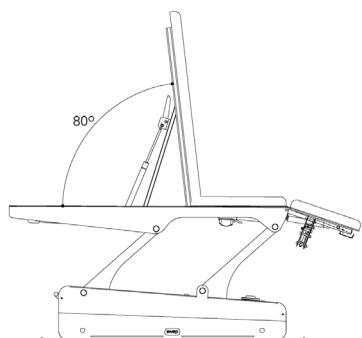
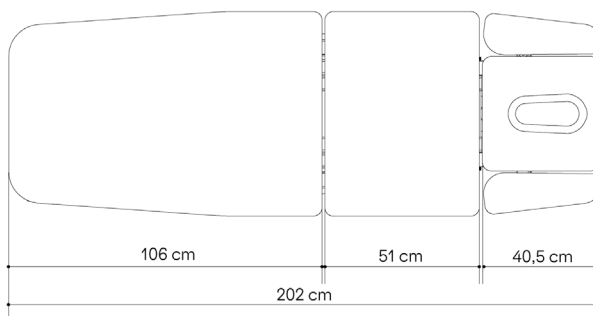
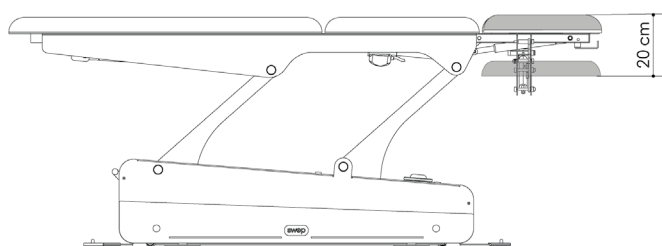
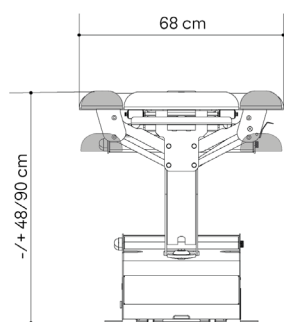



### Spécifications Générales

#### MOTEURS

1 moteur hauteur (6000 N)  
1 moteur section centrale (6000 N)

#### COULEUR DU CADRE

Space ball: RAL 7015  
Base Frame: RAL 7047

#### DIMENSIONS (LONGUEUR-LARGEUR)

202 x 68 cm

#### CLASSE D'ISOLATION

Isolation renforcée II

#### HAUTEUR (MIN. ET MAX.)

48/90 cm

#### CLASSIFICATION DU PRODUIT

Équipement de classe I

#### POIDS

102 kg

#### PARTIES APPLIQUÉES

Type B

#### CAPACITÉ DE CHARGE

200 kg

#### RÉSISTANCE À L'HUMIDITÉ

IPx0

#### ALIMENTATION

230 V - 50/60 Hz

#### CÂBLE D'ALIMENTATION

2,5m, Blanc

### Fonctionnement

Tête à trois parties avec système TwinLift®, réglable simultanément et en continu par vérin à gaz. Sans collision avec le thérapeute.

Tête à deux parties avec 2 vérins à gaz.

Le cadre périphérique SPACE BALL, facilement accessible de tous les côtés de la table.

4 roues 360°, entièrement intégrées au châssis, et 1 levier permettent de lever la table sur les 4 roues.

Section centrale avec moteur. Boutons placés au latéral de la table.

Jambières avec 1 vérin à gaz.

### Revêtement

Épaisseur: 5cm

Densité: 40kg/m<sup>3</sup>

Trou visage et bouchon amovible.

Revêtement sans coutures et bords arrondis.

Revêtement avec Naggura Skin : 100% composé de vinyle. Protection contre germes et rayons UV. Résistance supérieure à l'abrasion: >250K cycles.

Résistance à la flamme : NF P 92-503/M1

Couleur : Graphite

### Garantie et conformité

#### GARANTIE

2 ans sur la table et le revêtement

#### CONFORMITÉ

EN ISO 14971: 2019, EN ISO 20417:2021,

EN ISO 15223-1: 2016, ISO 10993-1: 2018,

EN ISO 10993-5: 2009, EN ISO 10993-10: 2013,

EN ISO 13485:2016,

EN 60601-2-52:2010+ AC:2011+A1:2015,

EN 60601-1-2:2015+ A1:2020,

EN 60601-1:2006+ A1:2013+AC:2014+A12:2014 +A2:2020

### Collections

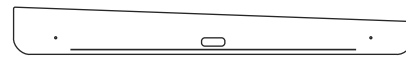

#### Nordic

METAL



Yellow



Blue



Pink

#### Foll

METAL



Ash



Clay

#### Iron

METAL



Inox



Black

#### Om

WOOD



Oak



Wenge

#### Techno

PMMA



Fluor



Fuxia



Ice

### Accessoires

#### Porte-rouleau



#### Housse de protection



### Sécurité

Verrouillage de sécurité avec clé (désactive les moteurs).

Moteur avec embrayage de sécurité.

# Swop 5 Physio

  Physiotherapy



## Dimensioni e Funzioni

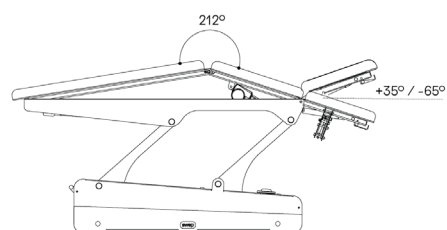
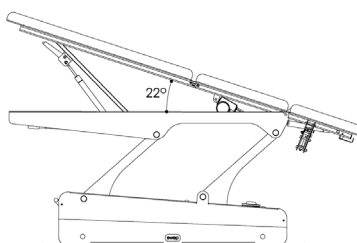
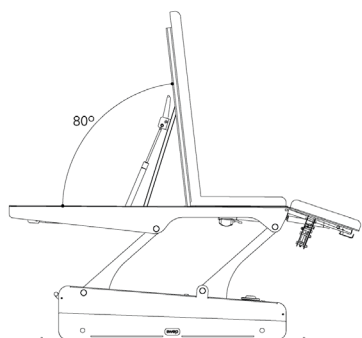
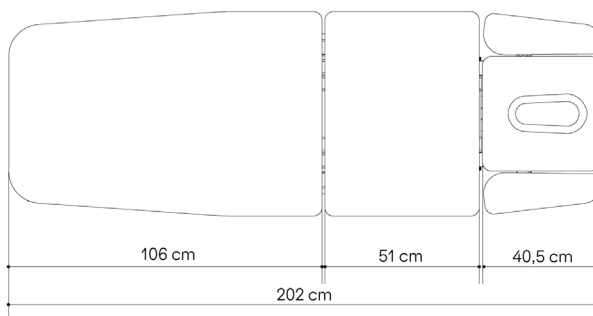
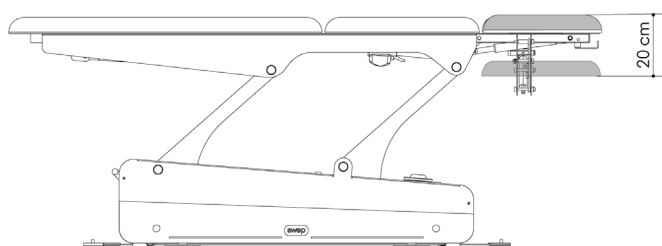
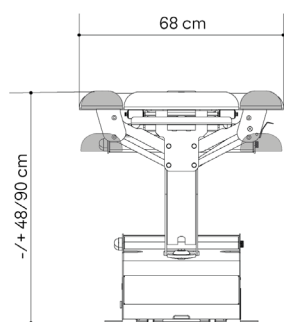





### Caratteristiche tecniche

#### MOTORI

1 motore altezza (6000 N)  
1 motore sezione centrale (6000 N)

#### DIMENSIONI (LUNGHEZZA-LARGHEZZA)

202 x 68 cm

#### ALTEZZA (MINIMA E MASSIMA)

48/90 cm

#### PESO

102 kg

#### CAPACITÀ DI CARICO

200 kg

#### ALIMENTAZIONE ELETTRICA

230 V - 50/60 Hz

#### COLORE DEL TELAIO

Space ball: RAL 7015  
Base Frame: RAL 7047

#### CLASSE DI ISOLAMENTO

Isolamento rinforzato II

#### CLASSIFICAZIONE PRODOTTO

Prodotto di Classe I

#### PARTI APPLICATE

Tipo B

#### RESISTENZA ALL'UMIDITÀ

IPx0

#### CAVO DI ALIMENTAZIONE

2,5m, Bianco

### Funzionalità

Sistema di supporto per le braccia © TwinLift, regolabile in modo simultaneo e continuo tramite pistone a gas, senza ostruzioni per il fisioterapista.

Testiera dotata di 2 pistoni a gas.

Sistema perimetrale sferico Space Ball, di facile accesso da tutti i lati del lettino.

4 ruote a 360° completamente integrate nel telaio. 1 leva solleva il lettino sulle sue 4 ruote.

Sezione centrale regolabile tramite motore elettrico, interruttori su entrambi i lati. Sezione podale con 1 pistone a gas.

### Imbottiture

Spessore: 5cm

Densità: 40kg/m<sup>3</sup>

Foro e cuscinetto facciale

Bordo arrotondato senza cuciture.

Rivestimento Naggura Skin: 100% Mix vinilico.

Protezione contro germi e raggi UV.

Resistenza superiore all'abrasione. > 250K

Resistenza alla fiamma: NF P 92-503 / M1

Colore: Grafite

### Garanzia e conformità

#### GARANZIA

2 anni sul lettino e il rivestimento

#### CONFORMITÀ

EN ISO 14971: 2019, EN ISO 20417:2021,

EN ISO 15223-1: 2016, ISO 10993-1: 2018,

EN ISO 10993-5: 2009, EN ISO 10993-10: 2013,

EN ISO 13485:2016,

EN 60601-2-52:2010+ AC:2011+A1:2015,

EN 60601-1-2:2015+ A1:2020,

EN 60601-1:2006+ A1:2013+AC:2014+A12:2014 +A2:2020

### Collezioni



#### Nordic

METAL



Yellow



Blue



Pink

#### Foll

METAL



Ash



Clay

#### Iron

METAL



Inox



Black

#### Om

WOOD



Oak



Wenge

#### Techno

PMMA



Fluor



Fuxia



Ice

### Accessori

#### Portarotoli



#### Coprilettini



### Sicurezza

Interruttore a chiave con chiave estraibile, disconnette tutti i motori.

Motore con sistema di sicurezza.

# Swop 5 Physio

  Physiotherapy



## Abmessungen und Funktionen

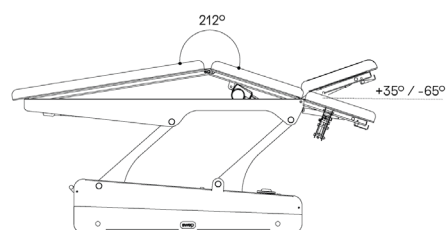
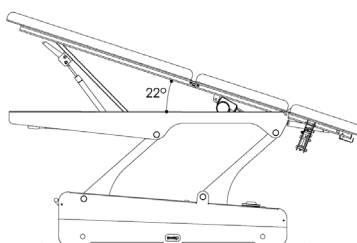
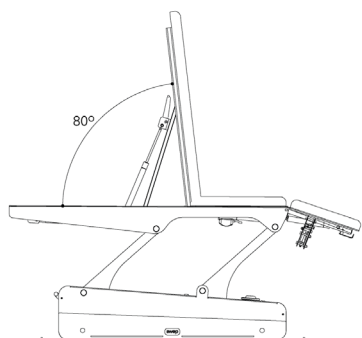
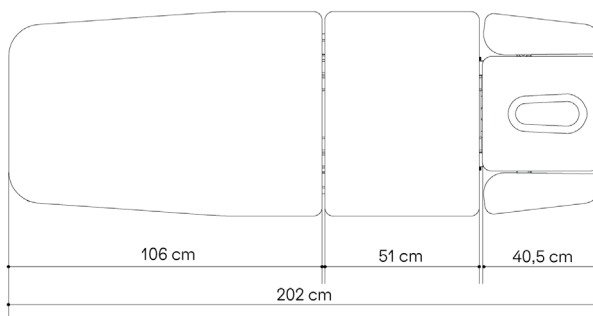
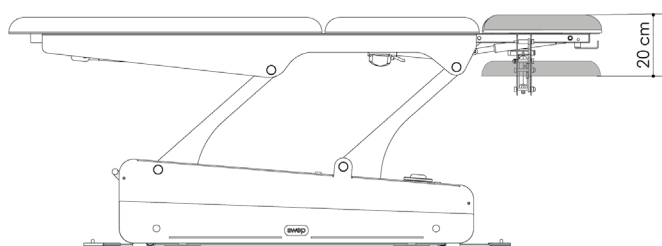
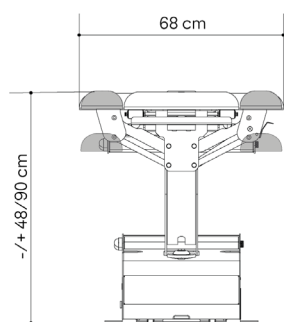

## Technische Angaben

### MOTOREN

1 Motor Höhenverstellung  
(6000 N)  
1 Motor elektrische  
Dachstellung (6000 N)

ABMESSUNGEN (LÄNGE-BREITE)  
202 x 68 cm

HÖHE (MIN. UND MAX.)  
48/90 cm

GEWICHT  
102 kg

BELASTBARKEIT  
200 kg

STROMVERSORGUNG  
230 V - 50/60 Hz

### RAHMENFARBE

Space ball: RAL 7015  
Base Frame: RAL 7047

DOPPELT ISOLIERT  
Doppelt isoliert II

GERÄTEKLASSIFIKATION  
Klasse I Equipment

ANGESCHLOSSENE TEILE  
Typ B

FEUCHTIGKEITSSCHUTZ  
IPx0

NETZKABEL  
2,5m, Weiß

## Funktionen

TwinLift ® Armstützen: per Gasfeder stufenlos und gleichzeitig verstellbar. Stört den Therapeuten nicht bei der Behandlung am Kopfteil

Kopfteil mit zwei Gasfedern für maximale Stabilität

Spaceball Rundumbedienung, von allen Seiten bedienbar

4 Räder 360°, unsichtbar im Untergestell integriert, zentral bedienbar.

Elektrisch bedienbares Mittelteil, mit Schalter an beiden Seiten. Fußteil mit einer Gasdruckfeder.

## Polster

Liegenfläche: 5cm

Dicker polsterung: 40kg/m<sup>3</sup>

Kopfteil mit Gesichtsöffnung und Verschlusskissen

Nahtlose und abgerundete Polster

Naggura Skin Polsterbezug: 100 % Vinyl-Mischung.

Schutz vor Keimen und UV-Strahlen.

Hochwertige Abriebfestigkeit: >250K Zyklen

Feuerwiderstandsklasse: NF P 92-503/M1

Farbe: Graphite

## Garantie und Konformität

### GARANTIE

3 Jahre auch auf Polsterbezug

### KONFORMITÄT

EN ISO 14971: 2019, EN ISO 20417:2021,

EN ISO 15223-1: 2016, ISO 10993-1: 2018,

EN ISO 10993-5: 2009, EN ISO 10993-10: 2013,

EN ISO 13485:2016,

EN 60601-2-52:2010+ AC:2011+A1:2015,

EN 60601-1-2:2015+ A1:2020,

EN 60601-1:2006+ A1:2013+AC:2014+A12:2014 +A2:2020

## Kollektionen

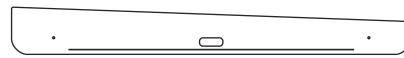

Nordic  
METAL



Yellow



Blue



Pink

Foll  
METAL



Ash



Clay

Iron  
METAL



Inox



Black

Om  
WOOD



Oak



Wenge

Techno  
PMMA



Fluor



Fuxia



Ice

## Zubehör

Papierrollenhalter



Froteebezüge



## Sicherheit

Sperrbox mit Schlüsselschalter, schaltet alle Motoren ab.

Motor mit Freikopplung

# Swop 5 Physio

  Physiotherapy



## Afmetingen en instelmogelijkheden

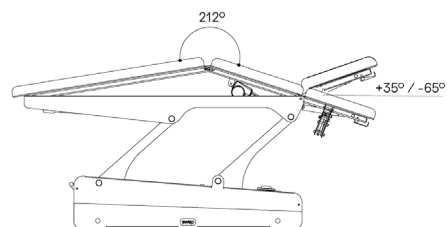
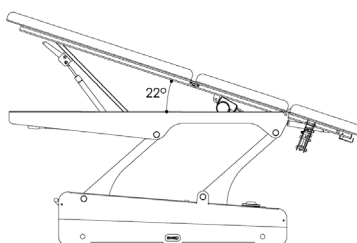
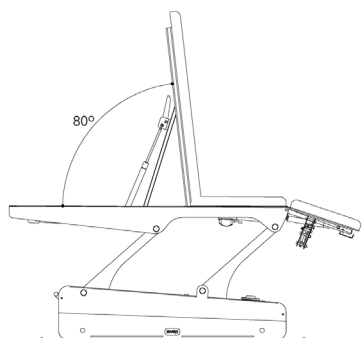
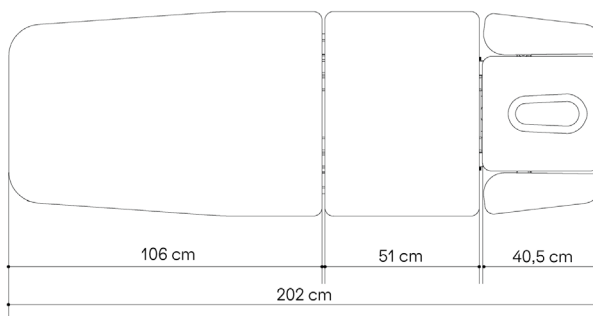
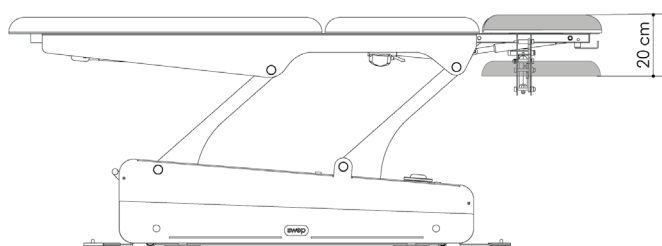
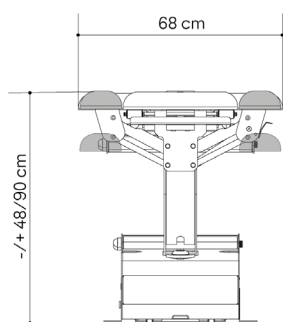

## Algemene Specificaties

### MOTOREN

1 motor elektrische hoogteverstelling (6000 N)  
1 motor elektrische pli-verstelling (6000 N)

AFMETINGEN (LENGTE-BREEDTE)  
202 x 68 cm

HOOGTE (MIN. AND MAX.)  
48/90 cm

GEWICHT  
102 kg

MAXIMALE DYNAMISCHE BELASTING 200 kg

STROOMVOORZIENING  
230 V - 50/60 Hz

KLEUR VAN HET FRAME  
Space ball: RAL 7015  
Base Frame: RAL 7047

ISOLATIE KLASSE  
Dubbel geïsoleerd II

PRODUKT KLASSE  
Klasse I apparaat

AANGEBRACHTE ONDERDELEN  
Type B

VOCHTBESTEDIGHEID  
IPx0

NETSNOER  
2,5m, wit

## Uitrusting

TwinLift® armsteunen: traploze en gelijktijdige instelling dmv een gasveer. Volledige bewegingsvrijheid onder het hoofddeel (knieën).

Het hoofddeel heeft 2 gasveren voor optimale stabiliteit.

Spaceball kringschakelaar, te bedienen aan alle zijden van de bank.

Wielmechanisme met 4 wielen, centraal te bedienen, onzichtbaar in het onderstel geïntegreerd.

Electrische pli-verstelling met schakelaars aan beide zijden. Voetdeel in te stellen dmv gasveer.

## Kussens

Dikte: 5cm

Polstering: 40kg/m<sup>3</sup>

Neusopening met uitneembaar gezichtskussen.

Kussens zonder naad met afgeronde hoeken.

Naggura Skin bekleding: 100% vinyl samenstelling.

Beschermt tegen bacteriën en UV stralen.

Superieure slijtagebestendigheid: >250K Martindale score.

Vlamvertragend: NF P 92-503/M1

Kleur: Graphite

## Garantie en conformiteit

### GARANTIE

3 jaar op bank en kunstleer

### CONFORMITEIT

EN ISO 14971: 2019, EN ISO 20417:2021,  
EN ISO 15223-1: 2016, ISO 10993-1: 2018,  
EN ISO 10993-5: 2009, EN ISO 10993-10: 2013,  
EN ISO 13485:2016,  
EN 60601-2-52:2010+ AC:2011+A1:2015,  
EN 60601-1-2:2015+ A1:2020,  
EN 60601-1:2006+ A1:2013+AC:2014+A12:2014 +A2:2020

## Collectie paneeltjes

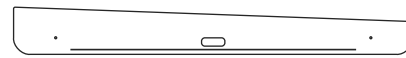

Nordic  
METAL



Yellow



Blue



Pink

Foll  
METAL



Ash



Clay

Iron  
METAL



Inox



Black

Om  
WOOD



Oak



Wenge

Techno  
PMMA



Fluor



Fuxia



Ice

## Toebehoren

Papierrolhouder



Hoezen



## Veiligheid

Veiligheidsschakelaar met afneembare sleutel (power off).

Motor met veiligheidsontkoppeling